

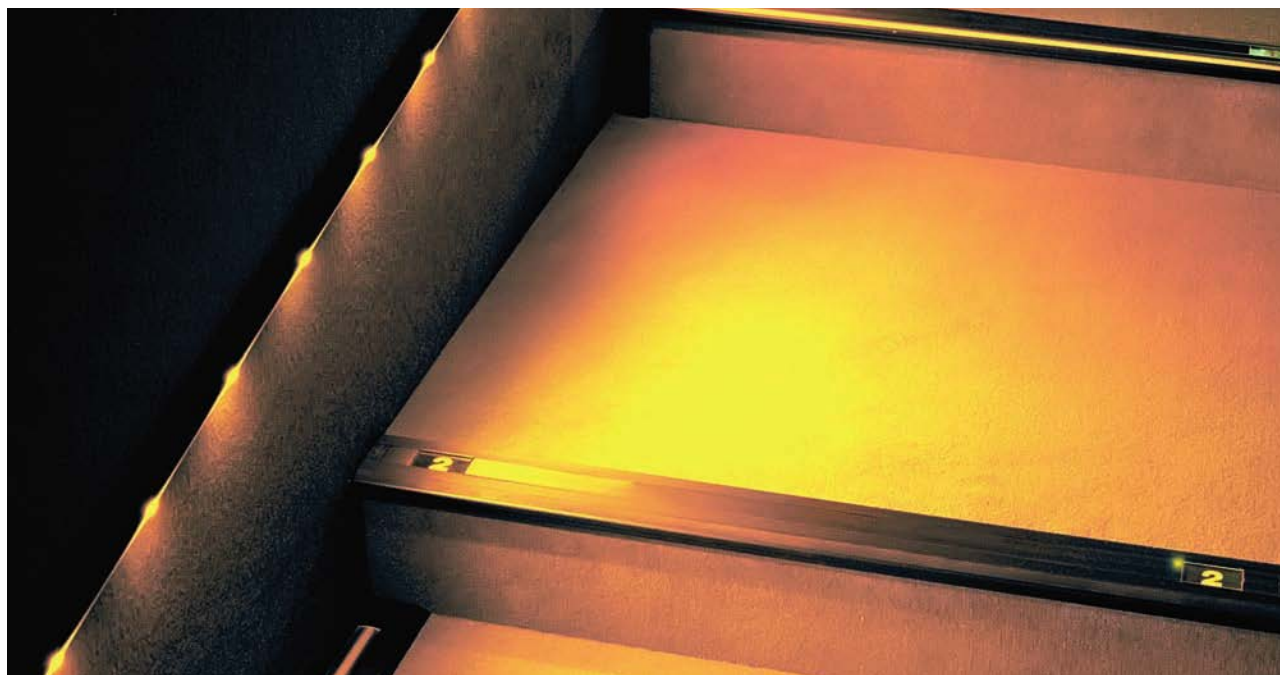

GUIDELINES perfil pared wall lighting



DATOS TÉCNICOS TECHNICAL DATA

Versión	Version	24V
Consumo	Consumption	Consultar Consult
Medidas	Dimensions	27 x 18,5 mm 1,06 x 0,72 in
Peso	Weight	0,19 kg/m
Material	Material	PVC
Clase de protección	Protection class	III
N° LEDs	LEDs quantity	15 LEDs/m
Aplicación	Application	Pared Wall
Uso	Use	Interior Indoor
Accesorios	Accessory	Transformador Transformer (excl)
Certificaciones	Certifications	CE / RoHS / ETL

PLANOS DRAWINGS

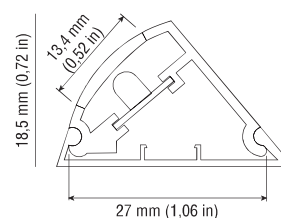

Ref	Descripción Description	Unidad Unit
M200003 (D/R)	Tapa de aluminio negro para acabado lado derecho / izquierdo	
M200004 (I/L)	Black aluminium end-plates left / right side as fine finish	1 u
)M210551(24V- 15 LEDs/m)	Bobina de 15 LED's/m. (6 m.) (12/24V DC) en azul, blanco, verde, rojo o amarillo Coil of 15 LED's/m. (6 m.) (12/24V DC) in blue, white, green, red or yellow	1 u



TECHNICAL DATA

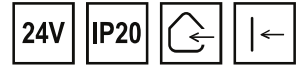

CONSUMPTION

7 LED's/yd:
24V - 1W/ ft

15 LED's/yd:
24V - 2.2W/ ft

Max Current
Per Run 2A

2.1 LED's/ft
max. 39 ft

4.5 LED's/ft
max. 16.4 ft

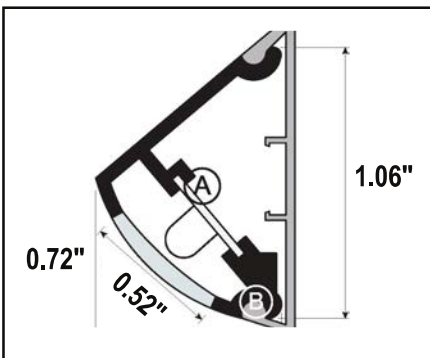

CONNECTION OF 24V DC TRANSFORMER

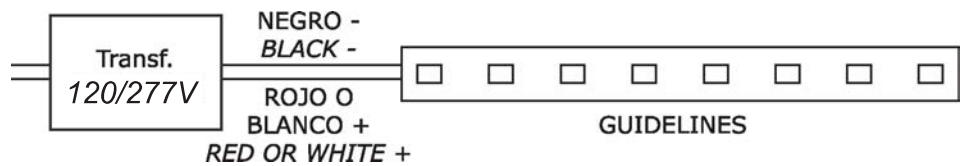

! USE EXTREME CAUTION WHILE UNFOLDING THE MULTIPLE BASE PROFILE EXTENSION SEGMENTS TO AVOID DAMAGING THE WIRE CONNECTING THEM TO EACH OTHER !

DIRECT SCREW-IN MOUNTING METHOD

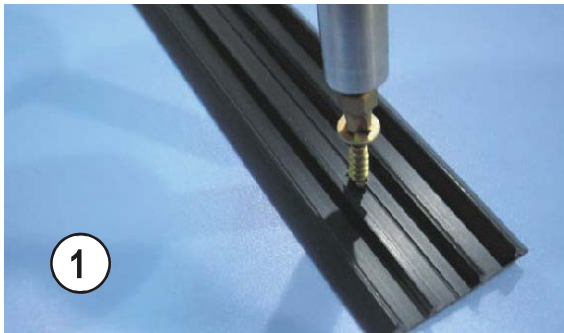

SCREW IN THE BASE PROFILE, USING A PLUG, IF NECESSARY.

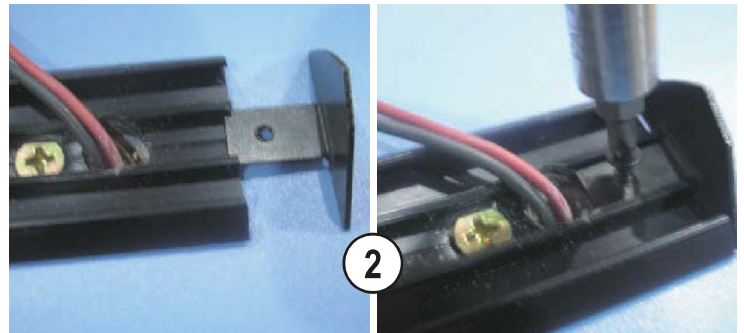

SCREW IN THE END CAPS INSERTING THEM IN THE CORRESPONDING GROOVES.

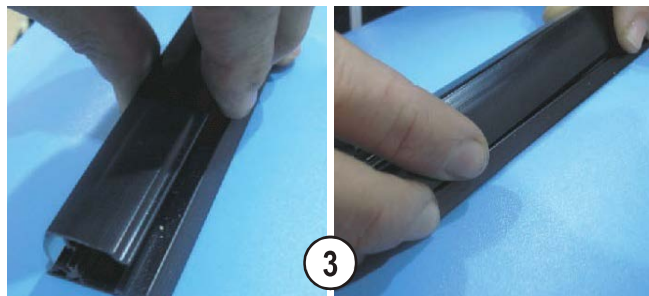

REST THE TRANSPARENT PART ON THE SUPPORT OF THE BASE PROFILE AND CLICK INTO THE PROFILE BY PRESSING GENTLY.

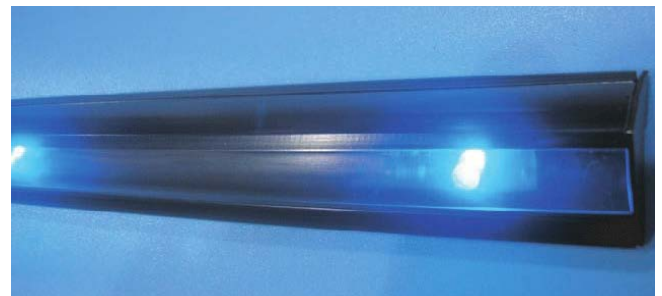

ASSEMBLED PRODUCT.

FIXING ON SMOOTH, NON-POROUS SURFACES (FINISHED ALUMINUM, GLASS, ETC.)

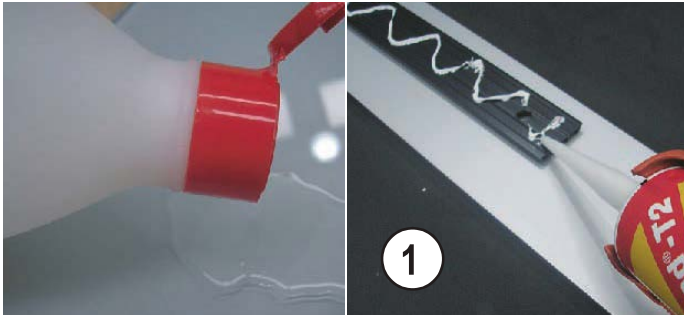

CLEAN BOTH SURFACES USING ALCOHOL. APPLY A UNIFORM THREAD OF CONSTRUCTION ADHESIVE.

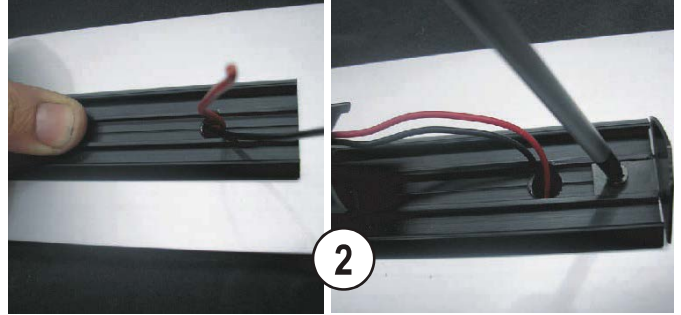

PRESS THE PROFILE ONTO THE SURFACE IT IS TO BE AFFIXED TO. INSTALL THE END CAPS (SEE PHOTO 3).

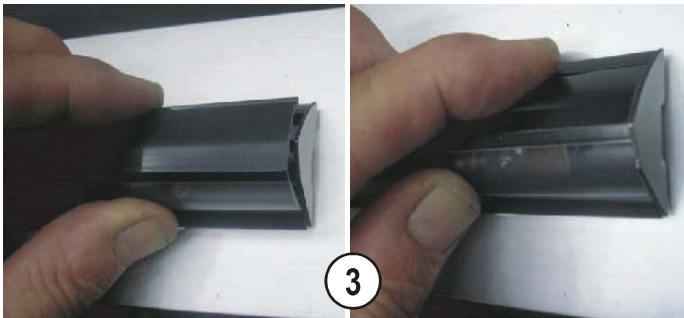

REST THE TRANSPARENT PART ON THE SUPPORT OF THE BASE PROFILE AND CLICK INTO THE PROFILE BY PRESSING GENTLY.



ASSEMBLED PRODUCT.