



Recessed Spots Fixed LED













D10108D | 8W | COB LED | Dark Light Recessed Spot





* New Construction Housing Available
Driver Enclosure = 8" x 10" x 6" w/10' Standard Connecting Cable
Installation Depth = 6.5"



3.46"



2.75"

Consult for dimming

FAMILY	ITEM#	WATTAGE	LUMENS	CCT	BEAM	FINISH	DRIVER	IP RATING	INPUT VOLTAGE
ABSECON	D10108D-W-W	8W	600lm	3000K	36°	WHITE	0-10V	IP20	120V - 277V
ABSECON	D10108D-B-W	8W	600lm	3000K	36°	BLACK	0-10V	IP20	120V - 277V
ABSECON	D10108D-BS-W	8W	600lm	3000K	36°	BRASS	0-10V	IP20	120V - 277V

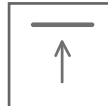

D10108R | 8W | COB LED | Recessed Spot

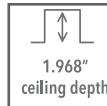
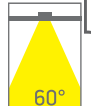

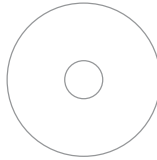

* New Construction Housing Available
Driver Enclosure = 8" x 10" x 6" w/10' Standard Connecting Cable
Installation Depth = 6.5"

3.188"

1.968"

Consult for dimming

FAMILY	ITEM#	WATTAGE	LUMENS	CCT	BEAM	FINISH	DRIVER	IP RATING	INPUT VOLTAGE
CASCO	D10108R-W-W	8W	560lm	3000K	60°	WHITE	0-10V	IP20	120V - 277V
CASCO	D10108R-B-W	8W	560lm	3000K	60°	BLACK	0-10V	IP20	120V - 277V











D10108A | 8W | COB LED | Dark Light Recessed Spot w/Asymmetric Reflector







* New Construction Housing Available
Driver Enclosure = 8" x 10" x 6" w/10' Standard Connecting Cable
Installation Depth = 6.5"

3.18"

2.91"

Consult for dimming

FAMILY	ITEM#	WATTAGE	LUMENS	CCT	BEAM	FINISH	DRIVER	IP RATING	INPUT VOLTAGE
MUNRO	D10108R-W-W	8W	560lm	3000K	50°	WHITE	0-10V	IP20	120V - 277V





LED BUILT IN

90 CRI





DIMMABLE
Consult Factory

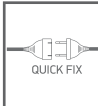

QUICK FIX

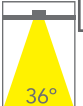

36°

D10107WD | 7W | COB LED | Dark Light Recessed Spot



3.07"



Driver Enclosure = 8" x 10" x 6" w/10' Standard Connecting Cable
Installation Depth = 6.5"

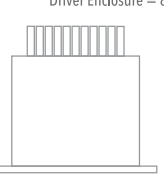

3"





* New Construction Housing Available
Consult for dimming

FAMILY	ITEM#	WATTAGE	LUMENS	CCT	BEAM	FINISH	DRIVER	IP RATING	INPUT VOLTAGE
PRIZE	D10107WD	7W	500lm	3000K	36°	WHITE	0-10V	IP54	120V - 277V



866.356.4458

solavantilighting.com











LED BUILT IN

80 CRI





2.95"

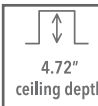

4.72"
ceiling depth

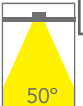

50°

D10113P | 15W | COB LED | Recessed Spot



3.54"



Driver Enclosure = 8" x 10" x 6" w/10' Standard Connecting Cable
Installation Depth = 6.5"

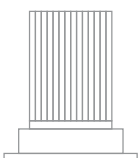

3.85"

* New Construction Housing Available
0-10V dimming option, available for 277V

FAMILY	ITEM#	WATTAGE	LUMENS	CCT	BEAM	FINISH	DRIVER	IP RATING	INPUT VOLTAGE
SHIGA	D10113P	15W	3000lm	3000K	50°	ALUM	0-10V	IP54	120V - 277V











D10106DH | 6W | COB LED | Dark Light Recessed Spot w/ Honeycomb





Remote Driver Enclosure = 6" x 10" x 2"
w/10' Standard Connecting Cable

2.75"

1.57"

Consult for dimming

FAMILY	ITEM#	WATTAGE	LUMENS	CCT	BEAM	FINISH	DRIVER	IP RATING	INPUT VOLTAGE
NICODH	D10106DH	6W	500lm	3000K	36°	WHITE	0-10V	IP20	120V - 277V











D10112DH | 12W | COB LED | Dark Light Recessed Spot w/ Honeycomb





* New Construction Housing Available
Driver Enclosure = 8" x 10" x 6" w/10' Standard Connecting Cable
Installation Depth = 6.5"

3.22"

1.57"

0-10V dimming option, available for 277V

FAMILY	ITEM#	WATTAGE	LUMENS	CCT	BEAM	FINISH	DRIVER	IP RATING	INPUT VOLTAGE
NICODH	D10112DH	12W	1000lm	3000K	36°	WHITE	0-10V	IP20	120V - 277V











D10118DH | 18W | COB LED | Dark Light Recessed Spot w/ Honeycomb







* New Construction Housing Available
Driver Enclosure = 8" x 10" x 6" w/10' Standard Connecting Cable
Installation Depth = 6.5"







4"

1.85"



0-10V dimming option, available for 277V

FAMILY	ITEM#	WATTAGE	LUMENS	CCT	BEAM	FINISH	DRIVER	IP RATING	INPUT VOLTAGE
NICODH	D10118DH	18W	1500lm	3000K	36°	WHITE	0-10V	IP20	120V - 277V

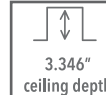
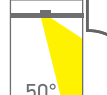

D50108A | 8W | COB LED | Dark Light Recessed Spot w/Asymmetric Reflector



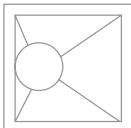
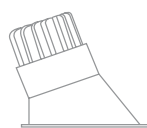









3.22" | 3.22" | 2.91"

* New Construction Housing Available
Driver Enclosure = 8" x 10" x 6" w/10' Standard Connecting Cable
Installation Depth = 6.5"



Consult for dimming

FAMILY	ITEM#	WATTAGE	LUMENS	CCT	BEAM	FINISH	DRIVER	IP RATING	INPUT VOLTAGE
MUNRO	D50108A	8W	560lm	3000K	50°	WHITE	0-10V	IP20	120V - 277V

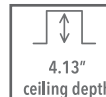
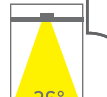

D10108D1 | 8W | COB LED | Dark Light Recessed Spot



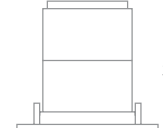





3.46" | 3.34"

* New Construction Housing Available
Driver Enclosure = 8" x 10" x 6" w/10' Standard Connecting Cable
Installation Depth = 6.5"

Consult for dimming

FAMILY	ITEM#	WATTAGE	LUMENS	CCT	BEAM	FINISH	DRIVER	IP RATING	INPUT VOLTAGE
HEALY	D10108D1	8W	560lm	3000K	36°	WHITE	0-10V	IP20	120V - 277V









D10108H | 8W | COB LED | Dark Light Recessed Spot

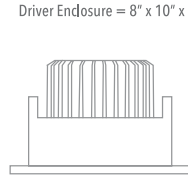

3.46" | 2.165"

* New Construction Housing Available
Driver Enclosure = 8" x 10" x 6" w/10' Standard Connecting Cable
Installation Depth = 6.5"

Consult for dimming

FAMILY	ITEM#	WATTAGE	LUMENS	CCT	BEAM	FINISH	DRIVER	IP RATING	INPUT VOLTAGE
MIDWAY	D10108HW	8W	600lm	3000K	36°	WHITE	0-10V	IP54	120V - 277V
MIDWAY	D10108HB	8W	600lm	3000K	36°	BLACK	0-10V	IP54	120V - 277V











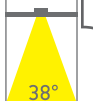

D10107DL | 7W | COB LED | Dark Light Recessed Spot





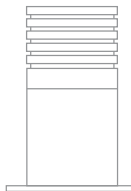

2.08"

3.54"

Remote Driver Enclosure = 6" x 10" x 2" w/10' Standard Connecting Cable

Consult for dimming

FAMILY	ITEM#	WATTAGE	LUMENS	CCT	BEAM	FINISH	DRIVER	IP RATING	INPUT VOLTAGE
SKIP	D10107DL	7W	450lm	3000K	38°	WHITE	0-10V	IP44	120V - 277V











D10112P | 12W | COB LED | Recessed Spot







3.26"

3.34"

* New Construction Housing Available
Driver Enclosure = 8" x 10" x 6" w/10' Standard Connecting Cable
Installation Depth = 6.5"

FAMILY	ITEM#	WATTAGE	LUMENS	CCT	BEAM	FINISH	DRIVER	IP RATING	INPUT VOLTAGE
ABE	D10112PW	12W	1100lm	3000K	40°	WHITE	0-10V	IP64	120V - 277V
ABE	D10112PB	12W	1100lm	3000K	40°	BLACK	0-10V	IP64	120V - 277V
ABE	D10112PAL	12W	1100lm	3000K	40°	ALUM	0-10V	IP64	120V - 277V
ABE	D10112PMC	12W	1100lm	3000K	40°	BR CHRM	0-10V	IP64	120V - 277V





	LED BUILT IN	80 CRI					
--	---------------------	---------------	--	--	--	--	--

D10112H | 12W | COB LED | Dark Light Recessed Spot

IP20
DARK LIGHT

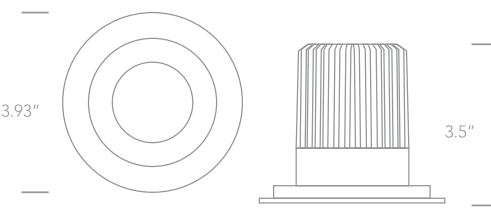

* New Construction Housing Available
Driver Enclosure = 8" x 10" x 6" w/10' Standard Connecting Cable
Installation Depth = 6.5"

3.93" ceiling depth

0-10V dimming option, available for 277V

FAMILY	ITEM#	WATTAGE	LUMENS	CCT	BEAM	FINISH	DRIVER	IP RATING	INPUT VOLTAGE
BINDO	D10112H	12W	850lm	2700K	40°	WHITE	0-10V	IP20	120V - 277V



	LED BUILT IN	80 CRI					
--	---------------------	---------------	--	--	--	--	--

D10112C | 12W | COB LED | Dark Light Recessed Spot

IP20
DARK LIGHT



* New Construction Housing Available
Driver Enclosure = 8" x 10" x 6" w/10' Standard Connecting Cable
Installation Depth = 6.5"

0-10V dimming option, available for 277V

FAMILY	ITEM#	WATTAGE	LUMENS	CCT	BEAM	FINISH	DRIVER	IP RATING	INPUT VOLTAGE
BINDO	D10112C	12W	1100lm	3000K	60°	WHITE	0-10V	IP20	120V - 277V











D10112E | 12W | COB LED | Dark Light Recessed Spot





* New Construction Housing Available

Driver Enclosure = 8" x 10" x 6" w/10' Standard Connecting Cable









Installation Depth = 6.5"

0-10V dimming option, available for 277V

FAMILY	ITEM#	WATTAGE	LUMENS	CCT	BEAM	FINISH	DRIVER	IP RATING	INPUT VOLTAGE
CRETE	D10112EW	12W	1100lm	4000K	40°	WHITE	0-10V	IP20	120V - 277V



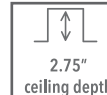

D10107CD | 7W | COB LED | Fixed Semi-dark Recessed Downlight

* New Construction Housing Available

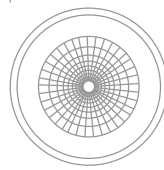
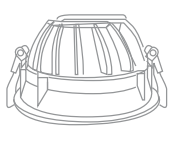
Driver Enclosure = 8" x 10" x 6" w/10' Standard Connecting Cable

Installation Depth = 6.5"

Consult for dimming

FAMILY	ITEM#	WATTAGE	LUMENS	CCT	BEAM	FINISH	DRIVER	IP RATING	INPUT VOLTAGE
PLATE	D10107CD	7W	560lm	4000K	180°	WHITE	0-10V	IP20	120V - 277V









D10112E | 12W | COB LED | Dark Light Recessed Spot













* New Construction Housing Available
Driver Enclosure = 8" x 10" x 6" w/10' Standard Connecting Cable
Installation Depth = 6.5"

0-10V dimming option, available for 277V

FAMILY	ITEM#	WATTAGE	LUMENS	CCT	BEAM	FINISH	DRIVER	IP RATING	INPUT VOLTAGE
CRETE	D10112EW	12W	1100lm	4000K	40°	WHITE	0-10V	IP20	120V - 277V



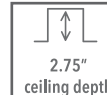

D10107CD | 7W | COB LED | Fixed Semi-dark Recessed Downlight



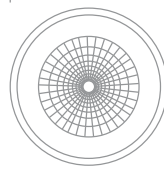
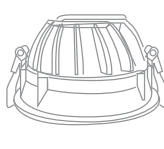







* New Construction Housing Available
Driver Enclosure = 8" x 10" x 6" w/10' Standard Connecting Cable
Installation Depth = 6.5"

Consult for dimming

FAMILY	ITEM#	WATTAGE	LUMENS	CCT	BEAM	FINISH	DRIVER	IP RATING	INPUT VOLTAGE
PLATE	D10107CD	7W	560lm	4000K	180°	WHITE	0-10V	IP20	120V - 277V





	LED BUILT IN	80 CRI					
Intertek					8.46"	3.93" ceiling depth	180°

D10130CD | 30W | COB LED | *Recessed Downlight, Semi-Dark Pro-Series*



IP20

9.05"

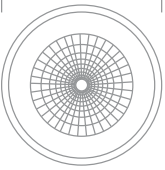
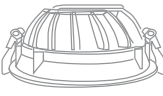







3.54"

Remote Driver Enclosure = 6" x 10" x 2"
w/10' Standard Connecting Cable

0-10V dimming option, available for 277V

FAMILY	ITEM#	WATTAGE	LUMENS	CCT	BEAM	FINISH	DRIVER	IP RATING	INPUT VOLTAGE
PLATE	D10130CD	30W	2400lm	4000K	180°	WHITE	0-10V	IP20	120V - 277V



	LED BUILT IN	80 CRI					
Intertek					6.3"	3.54" ceiling depth	180°

D10115CD | 15W | COB LED | *Fixed Semi-dark Recessed Downlight*



IP20

6.7"

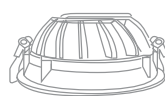



2.95"

* New Construction Housing Available
Driver Enclosure = 8" x 10" x 6" w/10' Standard Connecting Cable
Installation Depth = 6.5"

0-10V dimming option, available for 277V

FAMILY	ITEM#	WATTAGE	LUMENS	CCT	BEAM	FINISH	DRIVER	IP RATING	INPUT VOLTAGE
PLATE	D19115CD	15W	1200lm	4000K	180°	WHITE	0-10V	IP20	120V - 277V







LED BUILT IN

80 CRI







9.84"



3.93"
ceiling depth



180°

D10140CD | 40W | COB LED | *Recessed Downlight, Semi-Dark Pro-Series*



IP20

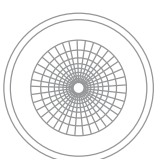

10.23"





3.54"

Remote Driver Enclosure = 6" x 10" x 2" w/10' Standard Connecting Cable

0-10V dimming option, available for 277V

FAMILY	ITEM#	WATTAGE	LUMENS	CCT	BEAM	FINISH	DRIVER	IP RATING	INPUT VOLTAGE
PLATE	D10140CD	40W	3200lm	4000K	180°	WHITE	0-10V	IP20	120V - 277V





LED BUILT IN

80 CRI







6.29"



5.9"
ceiling depth



120°

D10115 | 15W | LED | *Fixed Downlight*



IP44

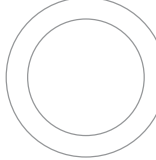

7.28"

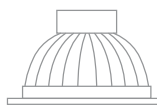



4.53"

Remote Driver Enclosure = 6" x 10" x 2" w/10' Standard Connecting Cable

0-10V dimming option, available for 277V

FAMILY	ITEM#	WATTAGE	LUMENS	CCT	BEAM	FINISH	DRIVER	IP RATING	INPUT VOLTAGE
ECO-D	D10115W	15W	2050lm	4000K	120°	WHITE	0-10V	IP44	120V - 277V
ECO-D	D10115G	15W	2050lm	4000K	120°	GREY	0-10V	IP44	120V - 277V







LED BUILT IN

80 CRI







8.26"



6.3"
ceiling depth



120°

D10124 | 24W | LED | *Fixed Downlight - Chrome Bezel*



IP44

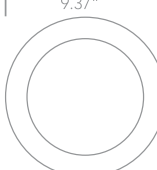

9.37"

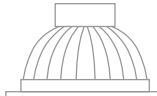

4.92"

Remote Driver Enclosure = 6" x 10" x 2" w/10' Standard Connecting Cable

Consult for dimming

FAMILY	ITEM#	WATTAGE	LUMENS	CCT	BEAM	FINISH	DRIVER	IP RATING	INPUT VOLTAGE
ECO-D	D10124W	24W	1550lm	4000K	120°	WHITE	0-10V	IP44	120V - 277V
ECO-D	D10124G	24W	1550lm	4000K	120°	GREY	0-10V	IP44	120V - 277V











D10106DC | 8W | COB LED | *Dark Light Recessed Spot, Dark Chrome Reflector*







Remote Driver Enclosure = 6" x 10" x 2"
w/10' Standard Connecting Cable

2.44" 2.125"

Consult for dimming

FAMILY	ITEM#	WATTAGE	LUMENS	CCT	BEAM	FINISH	DRIVER	IP RATING	INPUT VOLTAGE
NICODC	D10106DCW	8W	570lm	3000K	36°	WHITE	0-10V	IP20	120V - 277V
NICODC	D10106DCB	8W	570lm	3000K	36°	BLACK	0-10V	IP20	120V - 277V











D10112DC | 12W | COB LED | *Dark Light Recessed Spot, Dark Chrome Reflector*







* New Construction Housing Available
Driver Enclosure = 8" x 10" x 6" w/10' Standard Connecting Cable
Installation Depth = 6.5"

3.3" 2.75"

0-10V dimming option, available for 277V

FAMILY	ITEM#	WATTAGE	LUMENS	CCT	BEAM	FINISH	DRIVER	IP RATING	INPUT VOLTAGE
NICODC	D10112DCW	12W	1100lm	3000K	36°	WHITE	0-10V	IP20	120V - 277V
NICODC	D10112DCB	12W	1100lm	3000K	36°	BLACK	0-10V	IP20	120V - 277V











D10118DC | 18W | COB LED | *Dark Light Recessed Spot, Dark Chrome Reflector*







* New Construction Housing Available
Driver Enclosure = 8" x 10" x 6" w/10' Standard Connecting Cable
Installation Depth = 6.5"

4.09" 3.3"

0-10V dimming option, available for 277V

FAMILY	ITEM#	WATTAGE	LUMENS	CCT	BEAM	FINISH	DRIVER	IP RATING	INPUT VOLTAGE
NICODC	D10118DCW	18W	1750lm	3000K	36°	WHITE	0-10V	IP20	120V-277V
NICODC	D10118DCB	18W	1750lm	3000K	36°	BLACK	0-10V	IP20	120V-277V





LED
BUILT IN

90
CRI







1.96" x 1.77"

2.75"
ceiling depth



D50106B | 6W | COB LED | Recessed Spot, Dark Chrome Reflector





IP20

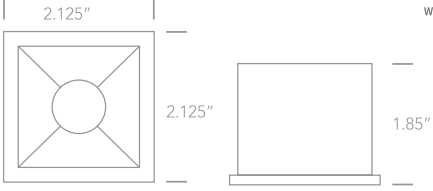





Remote Driver Enclosure = 6" x 10" x 2"
w/10' Standard Connecting Cable

Consult for dimming

FAMILY	ITEM#	WATTAGE	LUMENS	CCT	BEAM	FINISH	DRIVER	IP RATING	INPUT VOLTAGE
SENECA6	D50106BW	6W	480lm	3000K	38°	WHITE	0-10V	IP20	120V - 277V
SENECA6	D50106BB	6W	480lm	3000K	38°	BLACK	0-10V	IP20	120V - 277V







D50306B | 12W | COB LED | *Recessed Spot, Dark Chrome Reflector*

Remote Driver Enclosure = 6" x 10" x 2" w/10' Standard Connecting Cable

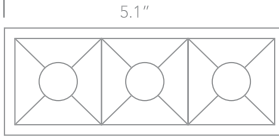











IP20

0-10V dimming option, available for 277V



FAMILY	ITEM#	WATTAGE	LUMENS	CCT	BEAM	FINISH	DRIVER	IP RATING	INPUT VOLTAGE
SENECA12	DD50306BW	12W	960lm	3000K	38°	WHITE	0-10V	IP20	120V - 277V
SENECA12	DD50306BB	12W	960lm	3000K	38°	BLACK	0-10V	IP20	120V - 277V



D50506B | 20W | COB LED | *Recessed Spot, Dark Chrome Reflector*

Remote Driver Enclosure = 6" x 10" x 2" w/10' Standard Connecting Cable

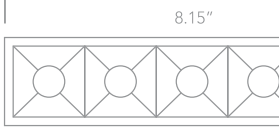











IP20

0-10V dimming option, available for 277V



FAMILY	ITEM#	WATTAGE	LUMENS	CCT	BEAM	FINISH	DRIVER	IP RATING	INPUT VOLTAGE
SENECA20	D50506BW	20W	1600lm	3000K	38°	WHITE	0-10V	IP20	120V - 277V
SENECA20	D50506BB	20W	1600lm	3000K	38°	BLACK	0-10V	IP20	120V - 277V



D50006B | 40W | COB LED | *Recessed Spot, Dark Chrome Reflector*

Remote Driver Enclosure = 6" x 10" x 2" w/10' Standard Connecting Cable

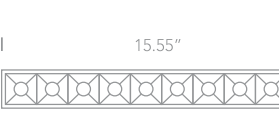









IP20

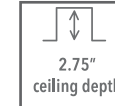
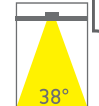

0-10V dimming option, available for 277V

FAMILY	ITEM#	WATTAGE	LUMENS	CCT	BEAM	FINISH	DRIVER	IP RATING	INPUT VOLTAGE
SENECA40	D50006BW	40W	3200lm	3000K	38°	WHITE	0-10V	IP20	120V - 277V
SENECA40	D50006BB	40W	3200lm	3000K	38°	BLACK	0-10V	IP20	120V - 277V



D50406B | 16W | COB LED | *Recessed Spot, Dark Chrome Reflector*

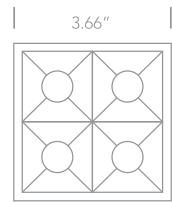









* New Construction Housing Available
Driver Enclosure = 8" x 10" x 6" w/10' Standard Connecting Cable
Installation Depth = 6.5"

0-10V dimming option, available for 277V



FAMILY	ITEM#	WATTAGE	LUMENS	CCT	BEAM	FINISH	DRIVER	IP RATING	INPUT VOLTAGE
SENECA16	D50406BW	16W	1280lm	3000K	38°	WHITE	0-10V	IP20	120V - 277V
SENECA16	D50406BB	16W	1280lm	3000K	38°	BLACK	0-10V	IP20	120V - 277V



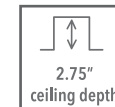
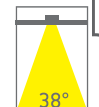

D50906B | 36W | COB LED | *Recessed Spot, Dark Chrome Reflector*

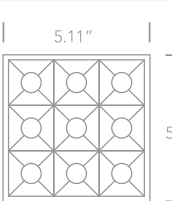
* New Construction Housing Available
Driver Enclosure = 8" x 10" x 6" w/10' Standard Connecting Cable
Installation Depth = 6.5"

0-10V dimming option, available for 277V

FAMILY	ITEM#	WATTAGE	LUMENS	CCT	BEAM	FINISH	DRIVER	IP RATING	INPUT VOLTAGE
SENECA36	DD50906BW	36W	2880lm	3000K	38°	WHITE	0-10V	IP20	120V - 277V
SENECA36	DD50906BB	36W	2880lm	3000K	38°	BLACK	0-10V	IP20	120V - 277V











D10102H | 2W | COB LED | *Dark Light Recessed Spot*





Remote Driver Enclosure = 6" x 10" x 2"
w/10' Standard Connecting Cable

120V Not dimmable,
277V consult for dimming

FAMILY	ITEM#	WATTAGE	LUMENS	CCT	BEAM	FINISH	DRIVER	IP RATING	INPUT VOLTAGE
MABY	D10102HW	2W	100lm	3000K	40°	WHITE	0-10V	IP65	120V - 277V
MABY	D10102HB	2W	100lm	3000K	40°	BLACK	0-10V	IP65	120V - 277V













D10107H | 7W | COB LED | *Dark Light Recessed Spot*





Remote Driver Enclosure = 6" x 10" x 2"
w/10' Standard Connecting Cable

Consult for dimming

FAMILY	ITEM#	WATTAGE	LUMENS	CCT	BEAM	FINISH	DRIVER	IP RATING	INPUT VOLTAGE
PRIZE	D10107H	7W	530lm	4000K	36°	WHITE	0-10V	IP65	120V - 277V





LED BUILT IN

80 CRI







QUICK FIX



40°

D10103P | 1W/3W | COB LED | *Recessed Spot*





1.8"



1.8"

Remote Driver Enclosure = 6" x 10" x 2"
w/10' Standard Connecting Cable

120V Not dimmable,
277V consult for dimming

FAMILY	ITEM#	WATTAGE	LUMENS	CCT	BEAM	FINISH	DRIVER	IP RATING	INPUT VOLTAGE
COB SEMI	D10103PW	1W / 3W	190lm	3000K	40°	WHITE	0-10V	IP65	120V - 277V
COB SEMI	D10103PB	1W / 3W	190lm	3000K	40°	BLACK	0-10V	IP65	120V - 277V
COB SEMI	D10103PAL	1W / 3W	190lm	3000K	40°	ALUM	0-10V	IP65	120V - 277V





LED BUILT IN

80 CRI







TRIAC DIMMABLE



FIRE RATED



60°

D10107DF | 7W | COB LED | *Fire-Rated Recessed Spot*





3.07"



2.56"

Remote Driver Enclosure = 6" x 10" x 2"
w/10' Standard Connecting Cable

277V, consult for dimming

FAMILY	ITEM#	WATTAGE	LUMENS	CCT	BEAM	FINISH	DRIVER	IP RATING	INPUT VOLTAGE
SKIP65F	D10107DFW	7W	500lm	3000K	60°	WHITE	0-10V	IP65	120V - 277V