



LINEAR FLEX

MONOCOLOR CRI 90



date

customer

project

quantity

The new ranges of Linear Flex® are the flexible linear LED solutions, for applications with curving linear surfaces or limited space. Those fixtures are used to provide high performance indirect lighting.

Linear Flex® is supplied in rolls with different power consumption. The Linear Flex® works under 24V DC and requires a power supply for its correct functioning.

The product is very flexible and can be installed easily onto any surface. It's small size enables it to be seamlessly integrated into architectural spaces.

Cove lighting and other applications

- 3 MacAdam: chromatic stability control
- 3 color temperatures: 2700K, 3000K, and 4000K
- Dimmable flexible strip
- It can be cut on size at site
- IP20
- Accessories: aluminum profile, diffuser and lenses

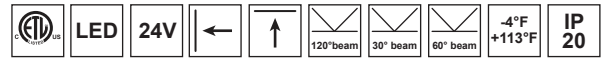

Family	Option / Wattage Per Foot	Color temp	Lens / Beam	Mounting	Driver	IP Rating	Input Voltage
L-FLEX	M901 3.9W/FT	27 2700K	NL NO LENS 120°	C CLIP B15 15° BRKT B30 30° BRKT B45 45° BRKT	N NON-DIM A 0-10V	20 IP20	24 24VDC
	M902 5.9W/FT	30 3000K	FC FLAT CLEAR 120°				
		40 4000K	FO FLAT OPAL 120°				
			HC HIGH CLEAR 120°				
			HO HIGH OPAL 120°				
			RC ROUND CLEAR 120°				
			RO ROUND OPAL 120°				
			C30 CLEAR LENS 30°				
			C60 CLEAR LENS 60°				

IP20

W/ft 3.9W 5.9W

CRI > 90

0.315" WIDTH REEL

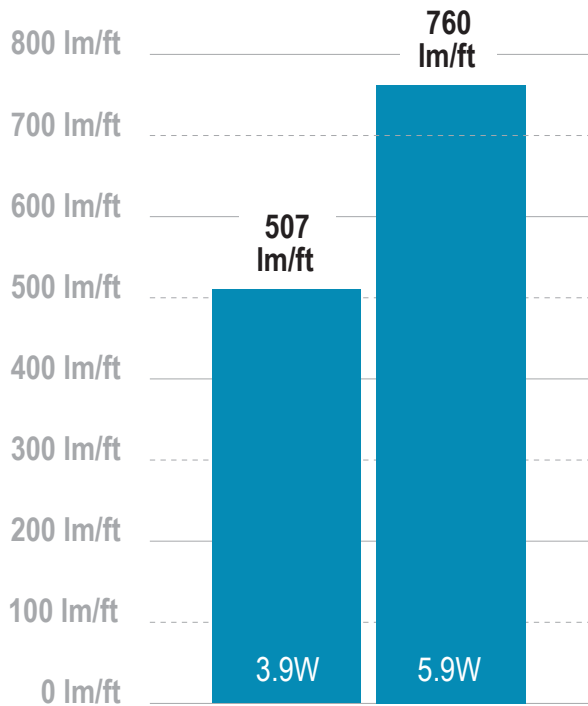

A Covers and lens

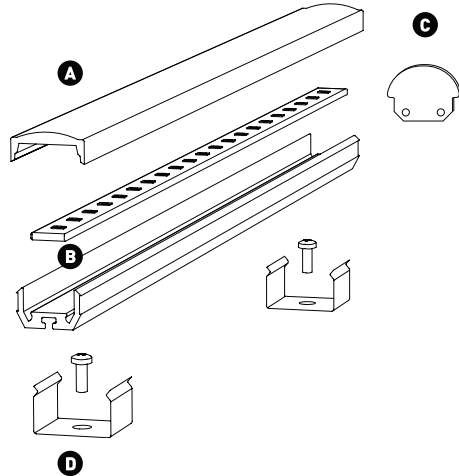
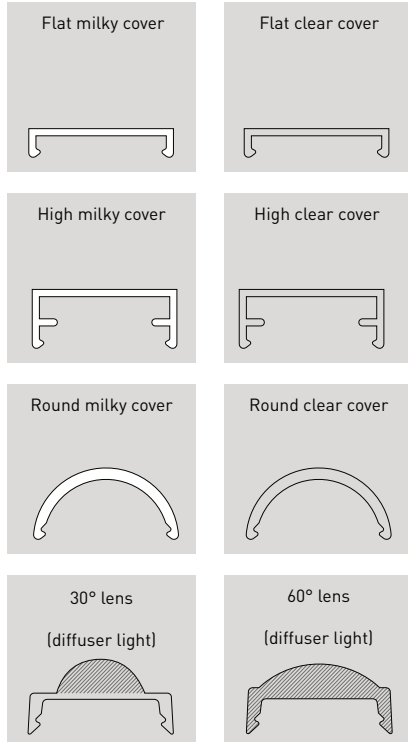

B Aluminum profile

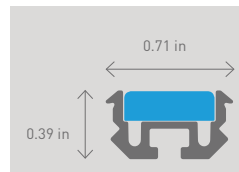

C End caps

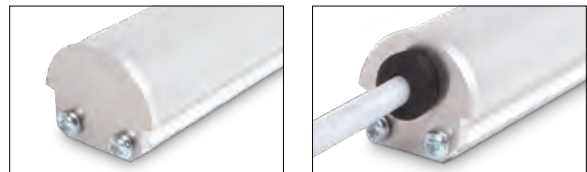

D Brackets

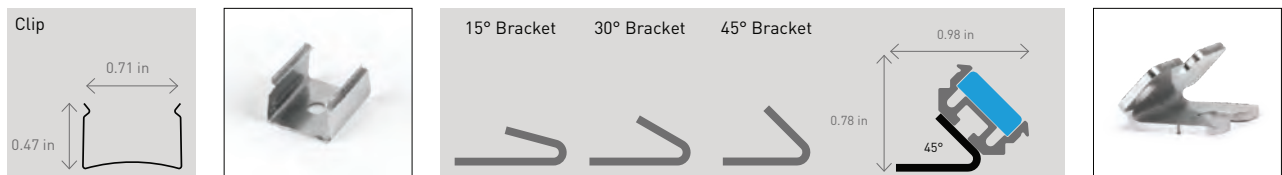

LED STRIP TABLE COMPATIBLE WITH END CAPS

Monocolor IP20					CRI>90		
4,8W/m	9,6W/m	14,4W/m	24W/m	33,6W/m	14,4W/m	24W/m	
✓	✓	✓	✓	✓	✓	✓	✓
IP67					RGB	RGBW	DW
4,8W/m	9,6W/m	14,4W/m	24W/m	14,4W/m	16,3W/m	19,2W/m	
✓	✓	✓	✓	✗	✗	✗	

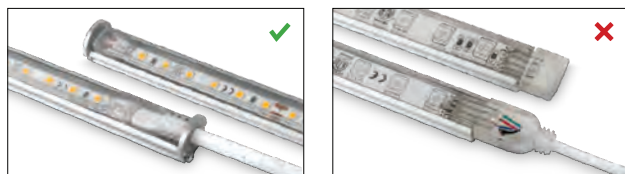

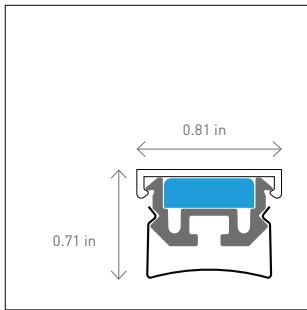

Al. Profile + Clip + Flat milky cover.

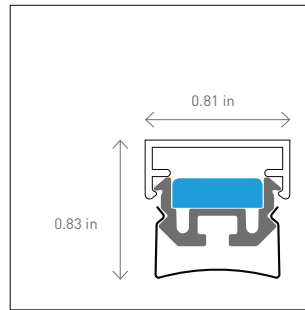

Al. Profile + Clip + High milky cover.

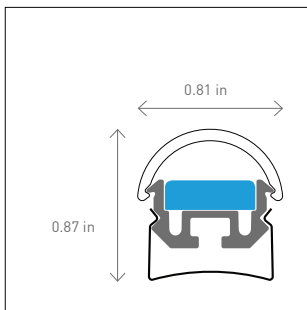

Al. Profile + Clip + Round clear cover.

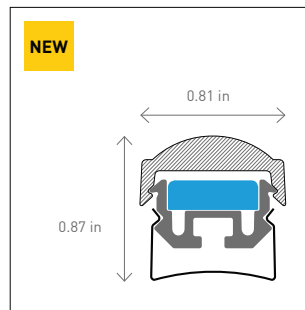

Al. Profile + Clip + 60° Lens.

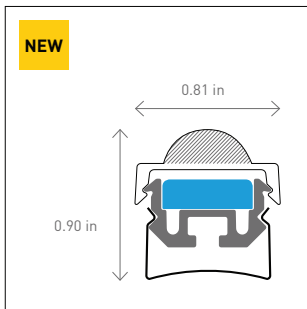

Al. Profile + Clip + 30° Lens.

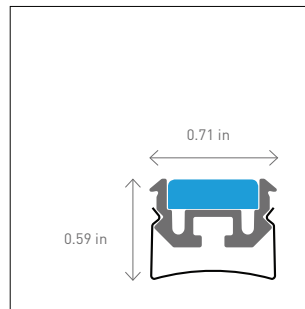

Al. Profile + Clip.

Full scale drawings.

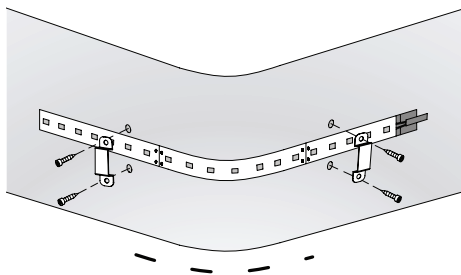

Screws and clips installation



Minimum bending radius 30 mm.



IP67
Temporarily immersion protection